

ONE unit for CIP applications, concentration monitoring and make-up

- ▲ Measurement value logging covering five decades of measurement ranges from 0-200 $\mu\text{S}/\text{cm}$ to 0-2 S/cm with an accuracy of $\pm 1 \mu\text{S}/\text{cm}$ at inductive conductivity measurement
- ▲ Equipped with Pt100 sensor, $-20^\circ\text{C} \dots +150^\circ\text{C}$
- ▲ Two electrically isolated current outputs 0/4-20 mA for conductivity and temperature
- ▲ USB port for simple updating and upgrading
- ▲ Alarm output with zero-potential changeover contact
- ▲ With the wall-mounted version a separate probe with 5 m or 20 m cable is connected to the transmitter
- ▲ Permanently lit display with:
 - Concentration display as weight percentages with product name or conductivity values in $\mu\text{S}/\text{cm}$ / mS/cm / S/cm
 - Measured temperature values in $^\circ\text{C}$ or $^\circ\text{F}$
 - Temperature coefficient and reference temperature (at conductivity measurement)
 - Output current values for conductivity and temperature
 - Active CIP field (only with configuration)
 - Operation symbols for the keys in the submenus
- ▲ Measure cell body (probe) is of the highly resistant material PEEK, without bonding seams and joint made in one cast
- ▲ Measure cell resistant to chemicals and temperature
- ▲ EHEDG-certified measure cell HD (hygienic design)

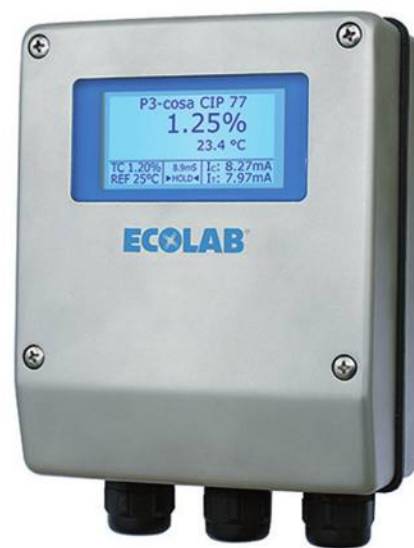

The **conductivity/temperature transmitter LMIT 09** offers process security due to an innovative measuring technology. The quality of a fluid is basically determined by measurement of its specific conductivity. Examples of this quality determination method are:

- ▲ Phase separation during CIP applications
- ▲ Concentration monitoring for detergent and disinfectant solutions
- ▲ Monitoring of water quality
- ▲ Quality control for liquid products
- ▲ Process control by online measuring
- ▲ Contamination monitoring of food

For an exact determination of substance concentrations, e.g. for detergents and disinfectants, it is essential to take the actual temperature into account. It is measured by means of the Pt100 temperature sensor, which shows optimal flow characteristics and a short response time ($T_{90} < 5 \text{ s}$).

All captured data are corrected with respect to the stored stereoscopic concentration graphs and temperature compensation factors. This results in an accurate and quick determination of the temperature and concentration of the conductive fluids.

Technical Data

Transmitter housing

Type:	Deep-drawn high-grade steel
Dimensions:	160 x 130 x 75 mm (L x B x H)
Weight:	Approx. 3 kg
Type of protection:	IP 67 acc. to DIN 40050
Housing bushings:	3 screw connections PG 13.5 (1 seal insert each for 4-6.5 / 5.5-9 / 6.5-10 mm)
Transducer connection:	PG 13.5; only for separate measuring cell version

Transducer

Type:	Cylindrical calotte with 10 mm measuring channel diameter
Material:	PEEK
Dimensions:	55 x 53 mm (d * h)
Pressure resistance:	PN = 16 bar at 20°C (see diagram)
Temperature stability:	Up to max. 130°C for short period up to max. 140°C (approx. 30 min)
Chemical resistance:	Resistent to inorganic acids and alkalis
Temperature sensor:	Pt 100 DIN in protective tube (material: 1.4404)
Sealing element:	<ul style="list-style-type: none"> ■ O-ring, 62 x 3 EPDM (Art. No. 417001502) for clamp ring attachment (VARIVENT) ■ Moulded seal, EPDM (Art. No. 415501251) for flange connection

Transmitter with integrated transducer (compact version)

Assembly:	Clamp ring attachment (VARIVENT-SYSTEM) or flange connection
Fitting type:	Flow fitting 1.4404 for installation in piping DN 40, 50, 65, 80 and 100 mm with weld connection. Weld-on ring (for VARIVENT system only) 1.4404, for installation in piping > DN 100. Weld-on ring 1.4404 for tank wall installation

Transmitter with separate transducer (wall-mounted version)

Transmitter assembly:	Fixing angle for wall mounting assembly
Transducer assembly:	Clamp ring attachment (VARIVENT system) or flange connection
Fitting type:	Flow fitting 1.4404 for installation in piping DN 40, 50, 65, 80 and 100 mm with weld connection. Weld-on ring (for VARIVENT system only) 1.4404, for installation in piping > DN 100. Weld-on ring 1.4404, for tank wall installation
Connection lead:	5 m (optional: 20 m)
Type of cable:	6-pole special measuring cable, cut to length
Connection measuring cable:	<ul style="list-style-type: none"> ■ fixed connection on sensor side ■ free wire ends with wire end ferrules on unit side



Conductivity measurement

Measuring principle:	Induction method
Measuring frequency:	Approx. 8 kHz
Conductivity measuring ranges:	0 ... 200 µS/cm 0 ... 2 mS/cm 0 ... 20 mS/cm 0 ... 200 mS/cm 0 ... 2 S/cm *measuring range limiting value: 2.5 S/cm or $[\alpha_{ref} * \alpha * (T - T_{ref}) < 2,5 \text{ S/cm}]$
Standard product measuring ranges:	NaOH = 0 ... 5 % by weight HNO ₃ = 0 ... 5 % by weight H ₂ SO ₄ = 0 ... 5 % by weight
Ecolab cleaning and disinfectant product measuring ranges:	0 ... 5 % by weight
Customer product measuring ranges:	Definition of four own product graphs with 4-10 nodes, temperature coefficient and reference temperature
Measuring range selection:	Via keyboard in unit or also 24 V control signals (for PROFIBUS version also via PROFIBUS DPV1/PA protocol); internally up to 5 conductivity measuring ranges and more than 70 product measuring ranges are available for selection
Conductivity display:	<ul style="list-style-type: none"> ■ digital, correct to 3 digits with units ■ conductivity in µS/cm, mS/cm or S/cm
Product display:	Product name and concentration in % by weight, digital, 3-digit

Temperature measurement

Measuring principle:	Resistance measurement with Pt 100 DIN using 3 wire connection method; linearization acc. to DIN IEC 751
Temperature measuring range:	-50° to 150° C
Temperature display:	digital 3 ½ digit in °C with a resolution of 0.1° C (above 100° C resolution 1° C)
Accuracy:	+/- 0.5° C (from 0 to 100° C)
Response time:	t ₉₀ < 5 sec. from 0 ... 90% for flowing medium

Temperature compensation

Reference temperatures:	0° C, 20° C, 25° C or manually adjustable (0°C ... 55°C); selectable with keyboard in unit
TC setting range:	0 ... 5 %/K in increments of 0.01 %/K; selectable with keyboard in unit
Function range of temperature compensation:	0 ... 100° C and $[Tk\alpha/100 * (T-T_{ref}) \geq - 0.5]$
TC display:	digital, 3 digit in %
Resolution:	0.01 %/K
Automatical Tkα determination:	call-up of function in the calibration menu; change of min. 5° C temperature necessary



Measured value outputs

<u>Current output conductivity:</u>	0(4) ... 20 mA for set measuring range, electrically isolated
Max. load impedance:	400 Ω
Electrical connection:	plug-in screw terminals
Range spread (SPAN) [20 mA]:	20 ... 150% of conductivity measuring range 20 ... 100% of product measuring range
Zero point suppression:	0(4) mA = 0 ... 80 % of measuring range
Damping:	OFF, 1...10 sec. adjustable (factory setting OFF)
Alarm current:	0 mA, 2.4 mA and 22 mA adjustable (factory setting 0 mA)
<u>Current output temperature:</u>	0(4) ... 20 mA, electrically isolated
Max. load impedance:	400 Ω
Electrical connection:	plug-in screw terminals
Range spread (SPAN):	20 mA = 50...150°C
Zero point suppression:	0(4) mA = - 10°C ... 50°C
Factory setting:	0(4) ... 20 mA = 0 ... 100°C
Damping:	OFF, 1...10 sec. adjustable (factory setting OFF)
Alarm current:	0 mA, 2.4 mA and 22 mA adjustable (factory setting 0 mA)

Power supply

Supply voltage:	24 V AC or DC
Tolerance:	± 15 %
Power consumption:	approx. 6 VA
Fuse protection:	5 x 20 mm miniature fuse 400 mA, slow-acting
Electrical connection:	plug-in screw terminals

Ambient conditions

Permitted ambient temperature:	0 ... 50°C
Influence of ambient temperature:	< 0,2 % / 10 K within the permitted range
Influence of supply voltage:	< 0,5 % within the permitted range
Permitted vibration:	10 ... 150 Hz, 20 m/s ²



Accuracy of conductivity measuring (referring to current output)

Conductivity measuring ranges:	0...200 $\mu\text{S}/\text{cm}^*$, 0...2/20/200 mS/cm und 0...2 S/cm
Linearity:	< 0.5 % of final value \pm 1 digit
Reproducibility:	< 0.5 % of final value \pm 1 digit
Zero point error:	< 0.5 % of final value \pm 1 digit
Load dependence:	< 0.2 %/100 Ω load change

* For standard devices: >10 $\mu\text{S}/\text{cm}$ after calibration in the employed flow fitting

Stored product data

HNO ₃	P3-cosa CIP 72	P3-horolith CIP	P3-mip EA	P3-polix XT
H ₂ SO ₄	P3-cosa CIP 77	P3-horolith FL	P3-mip FL	P3-Rinsa black
NaOH	P3-cosa CIP 92	P3-horolith KEG	P3-mip flüssig	P3-risil MAT
Ecofoam AC	P3-cosa CIP 95	P3-horolith MSW	P3-mip HP	P3-SR395
Ecofoam CL	P3-cosa FLUX 33	P3-horolith PA	P3-mip LF/LFT	P3-tresolin CIP
Ecofoam HA	P3-cosa FLUX 44	P3-horolith PM	P3-mip LH	P3-trimeta CID
P3-ansep ALU	P3-cosa FLUX 55	P3-horolith TR	P3-mip RC	P3-trimeta CIDsp
P3-ansep CIP	P3-cosa PUR 83	P3-horolith USP	P3-mip SP	P3-trimeta Duo
P3-aquanta BI	P3-cosa PUR 84	P3-horolith V	P3-mip TK	P3-trimeta ES
P3-aquanta OP	P3-flüssig 141	P3-liquid CIP	P3-mip VA	P3-trimeta HC
P3-aquanta PA	P3-flüssig 2083	P3-liquid OS	P3-mip VL	P3-trimeta MS
P3-aquanta PC	P3-flüssig OS	P3-mip 100	P3-mip zentra	P3-trimeta OP
P3-aquanta SI	P3-horolith 283	P3-mip AH	P3-N421	Trimeta Plus
P3-aquanta XTR	P3-horolith BSR	P3-mip ALU	P3-oxonia active S	Trimeta PSF
P3-AR extra	P3-horolith CD	P3-mip CIP	P3-oxysan CM	

Alarm output

Relay contact:	zero-potential changeover contact (max. 30 VDC / 1 A; 125 VAC / 0.3 A)
Function (reversible):	in case alarm relay has fallen (factory setting) or risen
Electrical connection:	plug-in screw terminals

CIP version (configurable)

additional components:

- 2 or 4 externally selectable CIP configurations and current output assignments
- selection of CIP configurations is effected by 24 V AC/DC signals

PROFIBUS version

additional components:

- up to 4 externally selectable CIP configurations and current output assignments
- external and internal configuration and parameterization (DPV1) as well as alarm and status messages
- interface: RS 485
- Baud rate: 9.6 kBaud up to 12 MBaud automatic Baud rate detection
- Connection resistance: 120 Ω , shiftable, lead type A

Note: We reserve the right to make technical modifications to our products in order to keep them up to date.



Order Data

Article/Designation	Material No.
---------------------	--------------

LMIT 09 Standard Version

Conductivity/Temperature Transmitter with clamp ring attachment:

Compact version	189201
Wall-mounted version, 5 m	189202
Wall-mounted version, 20 m	189203

Conductivity/Temperature Transmitter with flange attachment:

LMIT 09 HD version

Conductivity/Temperature Transmitter with clamp ring attachment:

Compact version	189209
Wall-mounted version, 5 m	189210

LMIT 09 PROFIBUS DPV1 version

Conductivity/Temperature Transmitter with clamp ring attachment:

Compact version	189206
Wall-mounted version, 5 m	189207

PROFIBUS PCB

For upgrading the standard version
for PROFIBUS DP/V1

289256

Power pack for LMIT 09 including a connecting cable

Primary stress 240 V AC (cable length: 1.5 m)
Secondary stress 24 V AC (cable length: 4.5 m)
System of protection IP 65

418931008

Conductivity simulator for LMIT 09

With 5 measuring-range-specific simulation resistors

289190

Conductivity simulator 200µS for LMIT 09

With measuring-range-specific simulation resistor

289191

Versions and Dimensions

compact version
tube installation
with clamp ring attachment

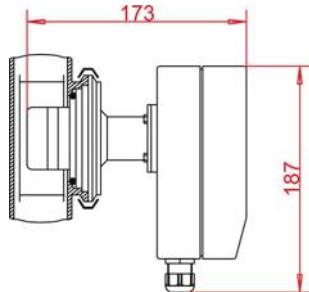

wall-mounted version

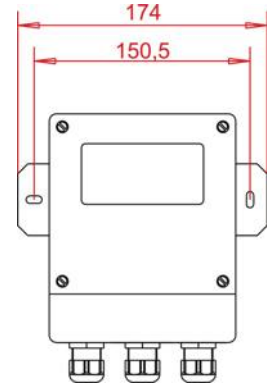

compact version
tube installation
with flange connection

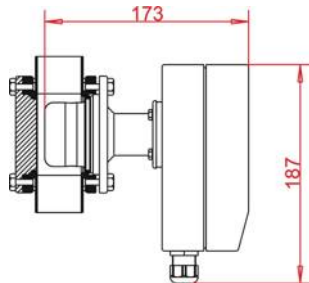

type:
flow fitting
(DIN 11850)

material:
1.4404, sealing EPDM

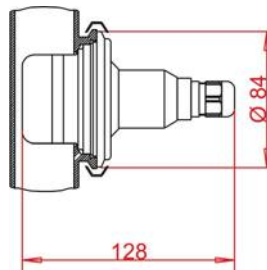

type:
weld-on ring for tank wall
installation

material:
1.4404, sealing EPDM

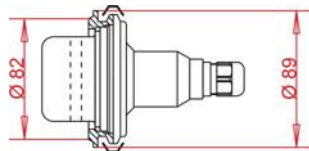

type:
weld-on ring for pipe
mounting

material:
1.4404, sealing EPDM

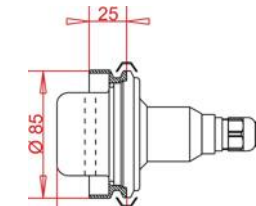

type:
weld-on ring for tank wall
installation

material:
1.4404, sealing EPDM

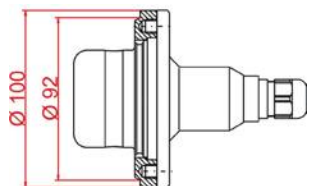

type:
flow fitting

material:
1.4404, sealing EPDM

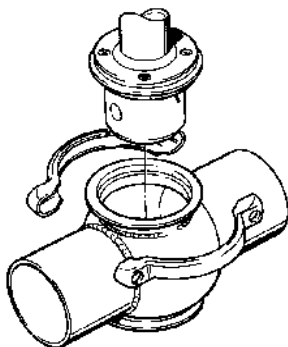
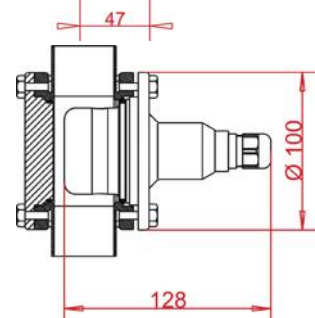

clamp ring attachment

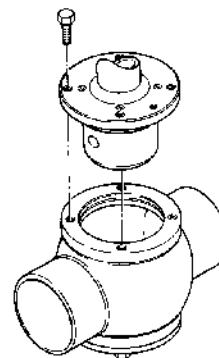

flange connection

Suggested Solution

Measurement system configuration in by-pass to circulation pump, with short return to tank

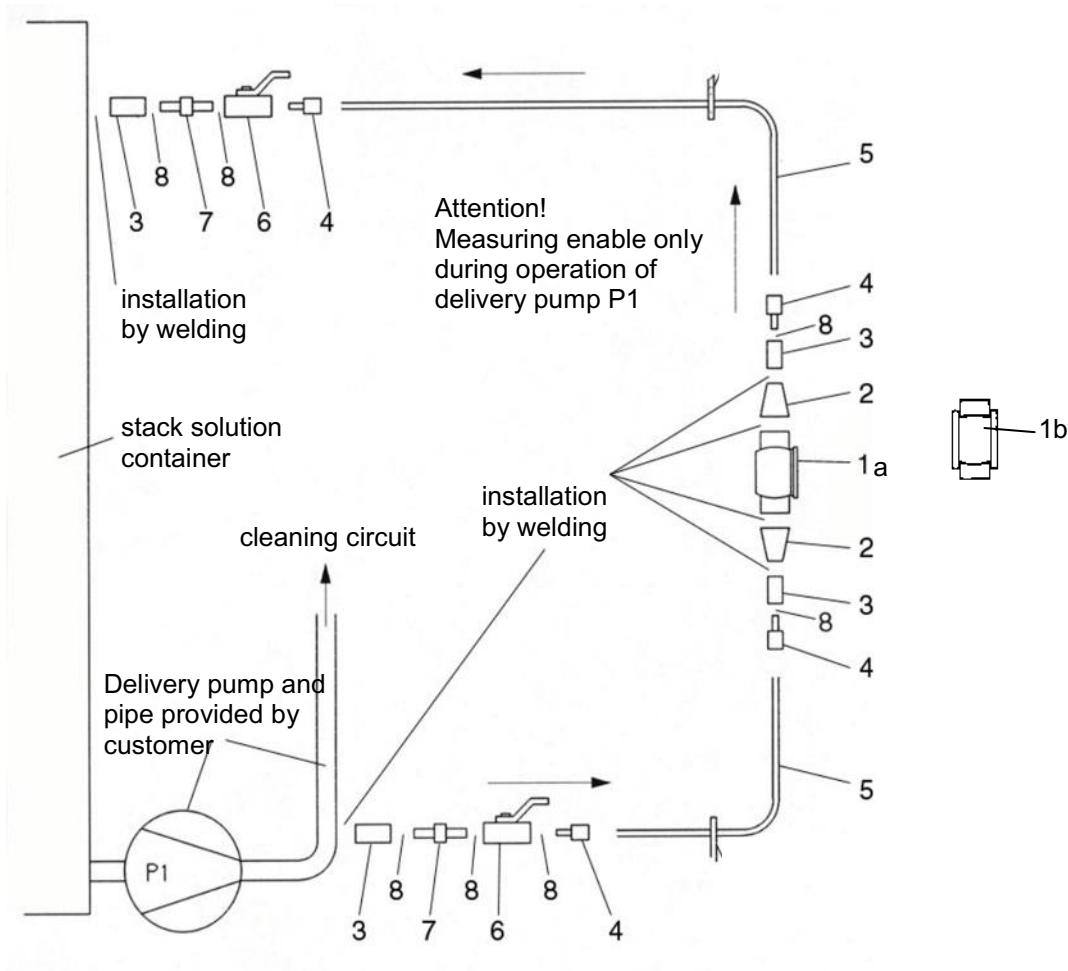

Measurement system configuration in by-pass, consisting of:

Item	Quantity	Material No.
1a or 1b	1	415501223
2	2	415508884
3	4	on request
4	4	415101885
5	4 m	415031164
6	2	415502024
7	2	415203604
8	1	417100813

Order Data

Article/Designation

Material No.

Flow-through housing with clamp ring attachment

Sealing material: EPDM
 Surface: matted
 Material: 1.4404

Housing , design:

2 open weld-on ends and clamp ring attachment for measuring calotte including all attachment parts, lock covers and seals

DN 40	415501223
DN 50	415501224
DN 65	415501220
DN 80	415501221
DN 100	415501222
Lock cover, 1.4571	415501232
Clamp ring set, 1.4571	415501231
Hexagon nut, 1.4301	413228215
Hexagon head screw, 1.4301	413000270
O-ring, EPDM, 62 x 3	417001502

Dimensions in mm

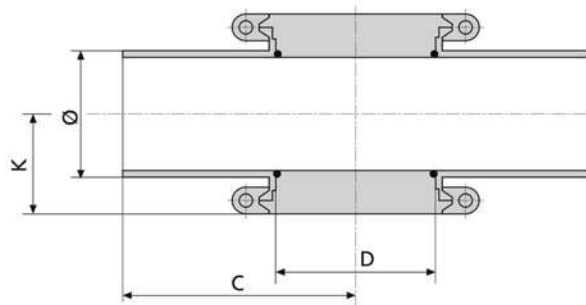

DN	C (length = 2 x C)	D	K
40	90	68	36
50	90	68	42
65	125	68	50
80	125	68	57,5
100	125	68	67
DN	weld-on endings Ø (external diameter)	internal diameter	wall thickness
40	41	38	1,5
50	53	50	1,5
65	70	66	2
80	85	81	2
100	104	100	2

Order Data – Accessories:

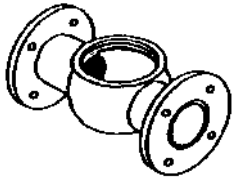

Article / Designation

Material No.

Flow-through housing with clamp ring attachment with flanges acc. to DIN 2633

Sealing Material: EPDM
Surface: matted
Material: 1.4404

DN 40 / PN 16
DN 50 / PN 16

on request
on request

Flow-through housing, chemical design but with Viton seal and halar-coated housing inside

DN 40 / PN 16
DN 50 / PN 16

on request
on request

O-ring Viton B 60 x 2

on request

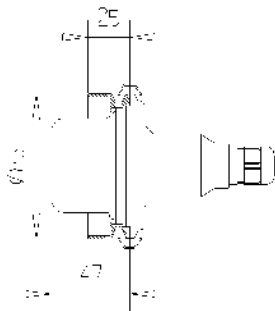

**Weld-on adapter with clamp ring attachment
Material: 1.4404**

Welding ring

for fitting of the LMIT 09 measuring cell into pipes >DN 100;
including attachment parts and sealing ring;
way of welding: welded muff

415501234

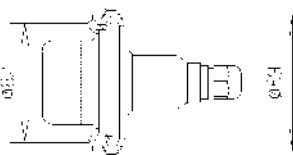

Weld-on ring

for fitting of the LMIT 09 measuring cell into the container side walls;
including attachment parts and sealing ring;
way of welding: welded muff

289033

Sealing ring, EPDM
Lock cover, 1.4571
Clamp ring set, 1.4571

417001502
415501232
415501231

Article / Designation

Material No.

Flow-through housing with flange attachment

Sealing Material: EPDM
 Surface: matted
 Material: 1.4404

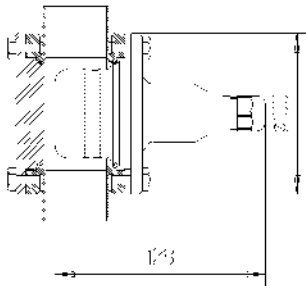

Housing, design:
 2 open weld-on ends and connection mouth for measuring calotte; including all attachment parts, lock covers and seals

DN 40
 DN 50
 DN 65
 DN 80
 DN 100

on request
 415501262
 415501263
 on request
 415501265

Form seal, EPDM

415501251

Weld-on ends			
DN	Ø external	Ø internal	wall thickness
40	41	38	1,5
50	53	50	1,5
65	70	66	2
80	85	81	2
100	104	100	2



Order Data – Spare Parts:

Article / Designation	Material No.
<p>LMIT 09 transducer with clamp ring attachment for wall-mounted version (not usable for HD version)</p> <p>cable length 5 m</p> <p>cable length 20 m</p>	<p>on request</p> <p>on request</p>
<p>LMIT 09 transducer with flange connection* for wall-mounted version, cable length 5 m</p>	<p>on request</p>
<p>LMIT 09 transducer with clamp ring attachment* Pharma version for wall-mounted version</p> <p>cable length 5 m</p>	<p>on request</p>

* Please also check the measuring transmitter before you replace the transducer. After the replacement of the transducer, the transmitter must be recalibrated in the used flow fitting. A check by the manufacturer is recommended!